

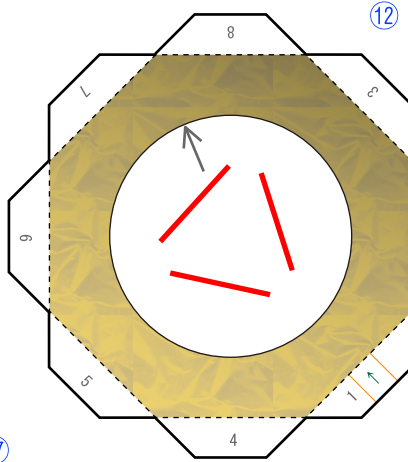

赤外線天文衛星 あかり ペーパークラフト

宇宙航空研究開発機構 宇宙科学研究所 赤外・サブミリ波天文学研究系

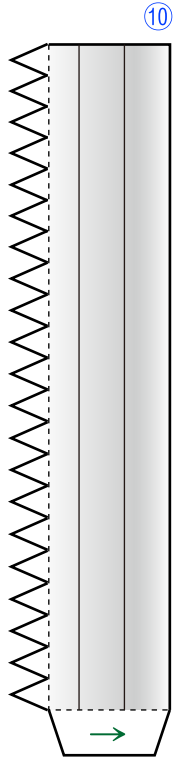
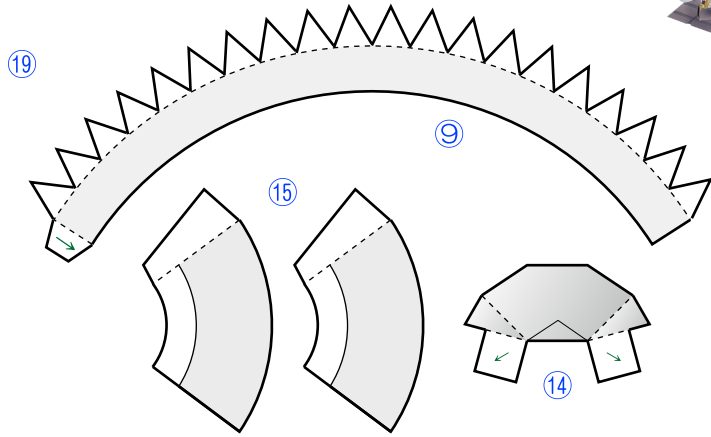
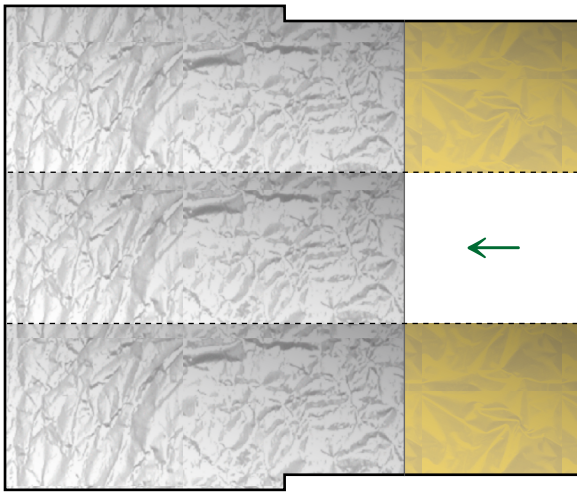
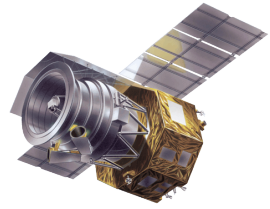

12

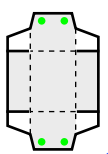
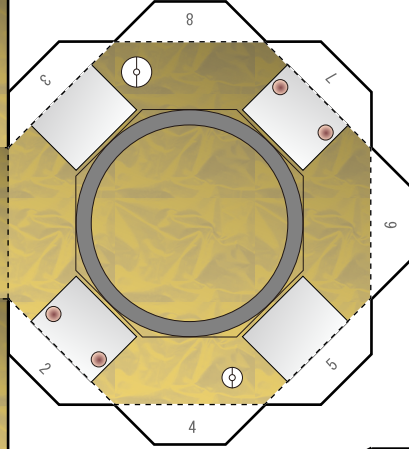

18

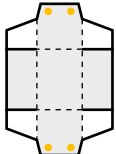

17

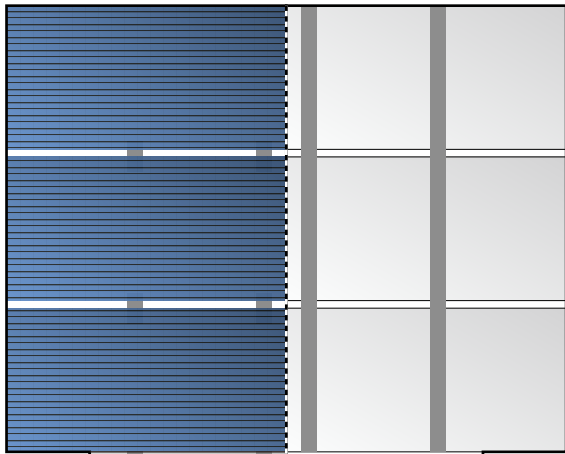

20



13



16



16



1

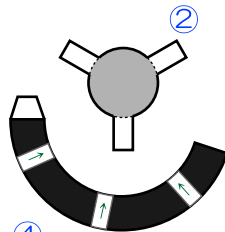

2

4

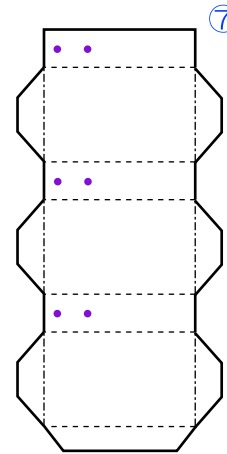

7

8

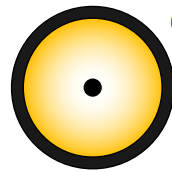
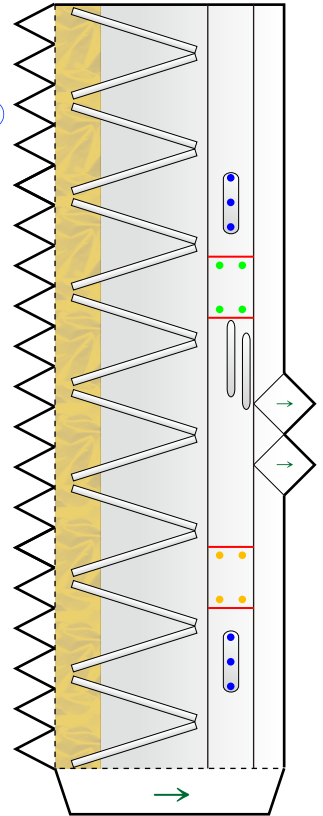

5

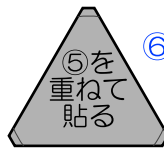

6

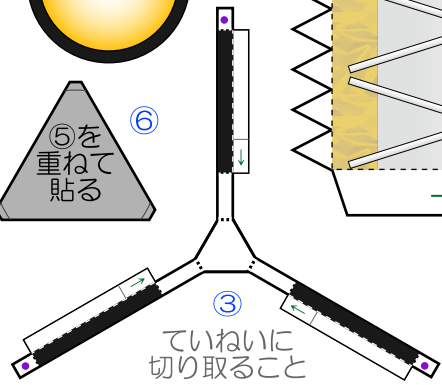

3

③をいねいに切り取る

